

IMPORTANT INFORMATION

DISCLAIMER

Thetford recommends and strongly advises users to engage the services of a qualified and licensed professional for the installation, maintenance, repair, or any other servicing needs associated with the product. The user understands and assumes full responsibility for hiring a professional with the requisite skills, knowledge, and qualifications to service your product. This includes, but is not limited to, tasks such as installation, repairs, modifications, or any other service required. Thetford disclaims any and all liability for any damages, losses, injuries, or other adverse consequences that may result from the user's failure to hire a qualified professional for the servicing of your product. The user acknowledges the importance of ensuring that the hired professional adheres to industry standards, guidelines, and local regulations applicable to the servicing of your product. Thetford is not responsible for the actions, omissions, or negligence of the hired professional. The user agrees to indemnify and hold harmless Thetford from any claims, liabilities, damages, costs, or expenses, including legal fees, arising from the user's decision to hire, or not hire, a professional for the servicing of the product. By using your product, the user affirms that they have read, understood, and voluntarily agreed to this disclaimer.

Content

- Service mode
- Possible error codes
- Troubleshooting/diagnostic diagrams
- General problem solution
- Wiring diagrams

Service mode



When an error occur, the power LED will turn red or orange.

Temperature settings will give a certain pattern.

Each bar combination is indicating a different error code.

Example:

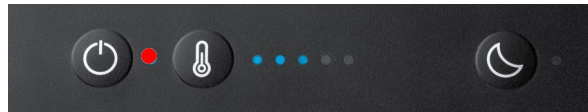



This display indicates $16+8+4 >$ error code 28

















Refer to the error code table.

01	□ □ □ □	17	□ □ □ □
02	□ □ □ □	18	□ □ □ □
03	□ □ □ □	19	□ □ □ □
04	□ □ □ □	20	□ □ □ □
05	□ □ □ □	21	□ □ □ □
06	□ □ □ □	22	□ □ □ □
07	□ □ □ □	23	□ □ □ □
08	□ □ □ □	24	□ □ □ □
09	□ □ □ □	25	□ □ □ □
10	□ □ □ □	26	□ □ □ □
11	□ □ □ □	27	□ □ □ □
12	□ □ □ □	28	□ □ □ □
13	□ □ □ □	29	□ □ □ □
14	□ □ □ □	30	□ □ □ □
15	□ □ □ □	31	□ □ □ □
16	□ □ □ □		

Note: the refrigerator can have multiple errors. The errors alternate in the display.

E.g. first the display shows  but then suddenly it shows code:  This means there are two errors, both 14 and 20 need to be solved.

Possible error codes

Display	LED colour	Error code	Description
 	Red (continuously)	14	Fan cabinet defect
 	Orange (continuously)	15	Fan condenser defect
 	Red flashes	20	Thermistor cabinet defect
 	Red flashes	21	Thermistor freezer defect
 	Red flashes	22	Thermistor ambient defect
 	Orange (continuously)	23	CI-Bus command not recognized
 	Red flashes	25	Insufficient power to the refrigerator; voltage too low or too high
	Red flashes	None	Door open too long/contact not recognized
LEGEND  Red error > repair the refrigerator immediately  Orange error > a problem occurs, but the refrigerator continues to operate (performance may be reduced)			

Red flashes: no error code

Applicable for: T2090, T2120, T2152, T2156

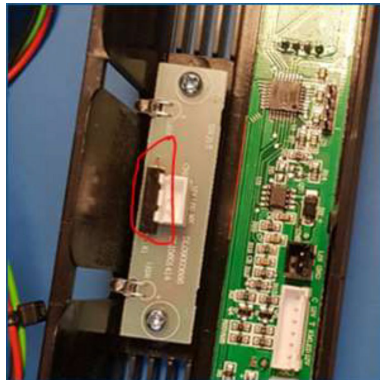
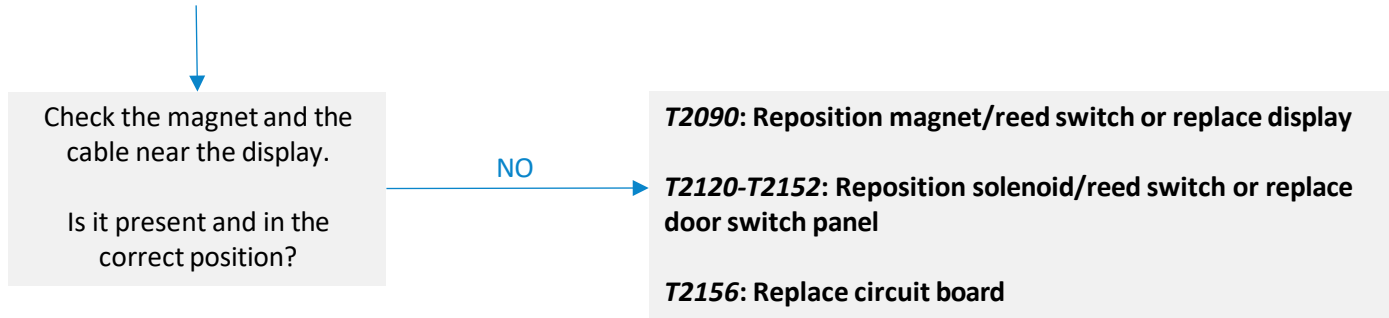

Note: if the **door is left open** for more than two minutes, the interior **lighting goes out** and the **cooling stops**. Refrigerator restarts automatically when door is closed.

T2090 refrigerators with serial numbers before SN#080XDW00652 can also display the error.

Red flashes: no error code

Applicable for: T2095, T2138, T2160, T2175

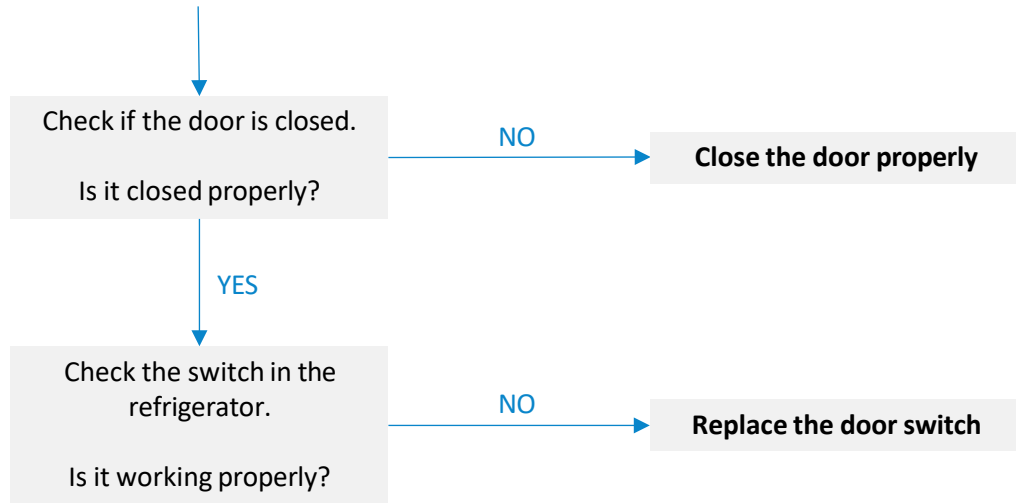

Error code 14: Fan cabinet defect

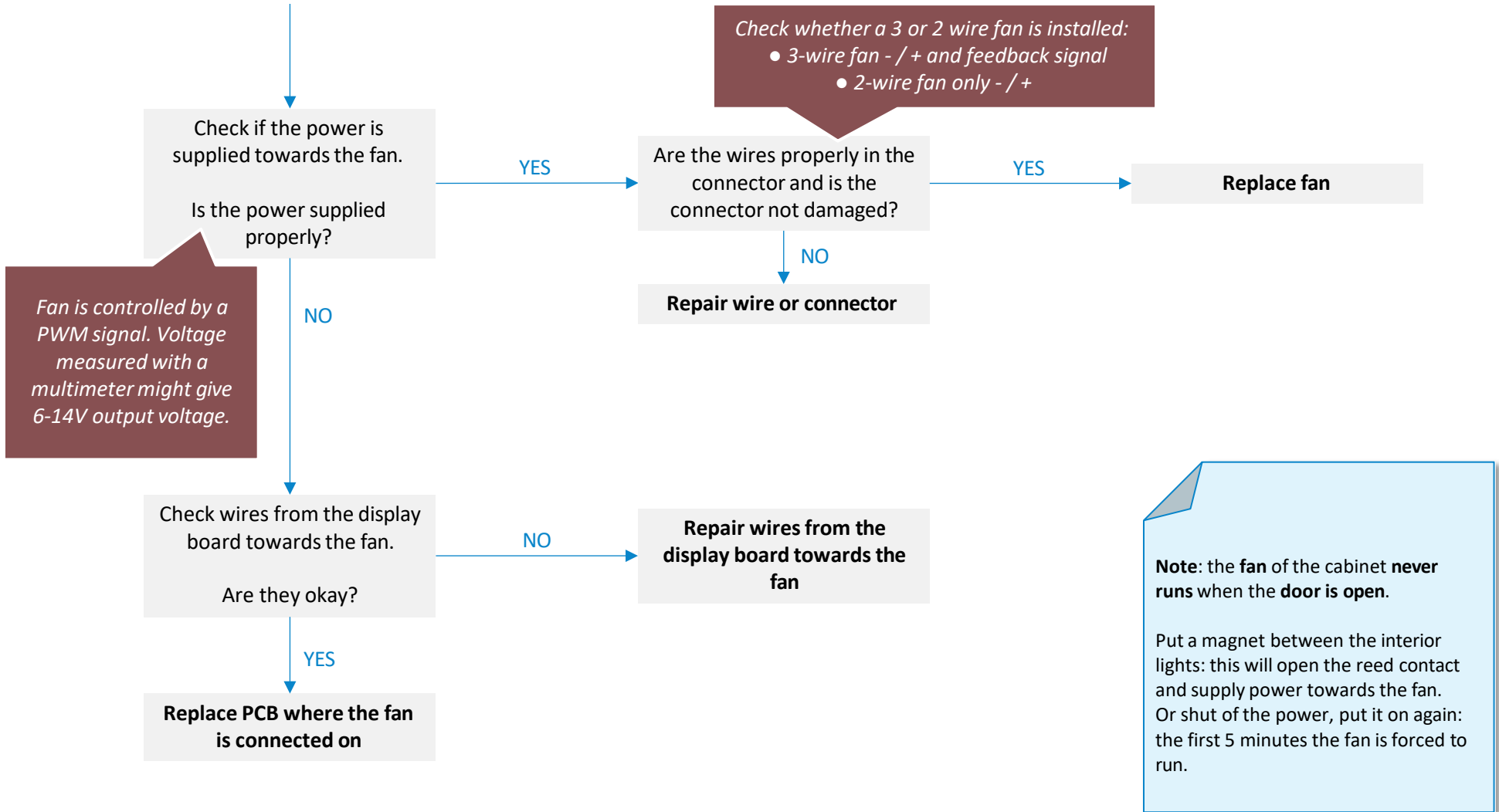

Error code 15: Fan condenser defect

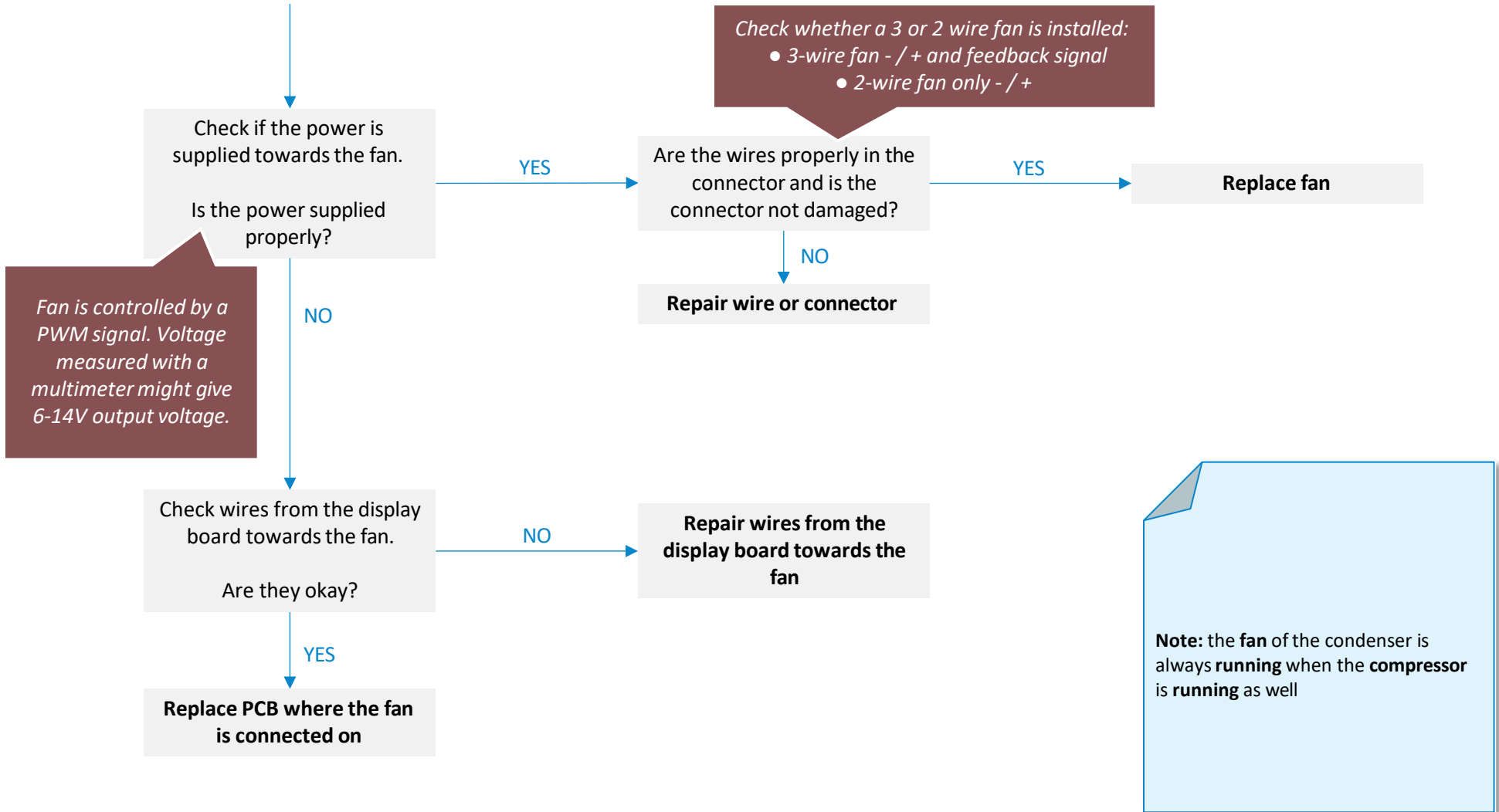

Error code 20-21-22: Thermistor cabinet, freezer, ambient defect

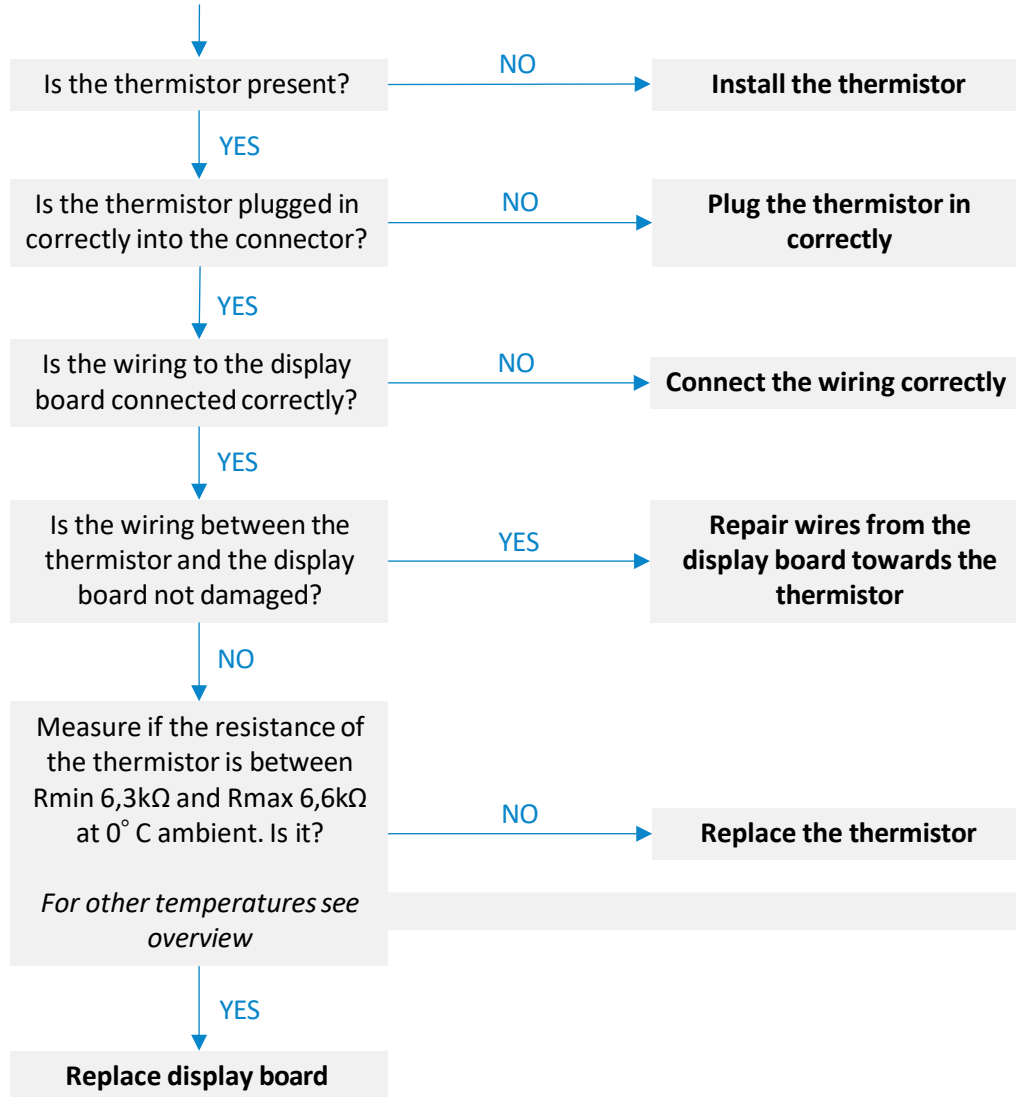

Note T2152: The thermistor for ambient temperature is placed underneath the refrigerator.

T(°C)	Rmin	Rmax
0	6,3	6,7
1	6,0	6,3
2	5,7	6,0
3	5,5	5,7
4	5,2	5,4
5	5,0	5,2
6	4,7	4,9
7	4,5	4,7
8	4,3	4,5
9	4,1	4,3
10	3,9	4,1
11	3,7	3,9
12	3,5	3,7
13	3,4	3,5
14	3,2	3,4
15	3,0	3,2
16	2,9	3,1
17	2,8	3,0
18	2,6	2,8
19	2,5	2,7
20	2,4	2,6
21	2,3	2,5
22	2,2	2,4
23	2,1	2,3
24	2,0	2,2
25	1,9	2,1
26	1,8	2,0
27	1,8	1,9
28	1,7	1,8
29	1,6	1,8
30	1,6	1,7

Error code 23: Error in the CI-Bus connection

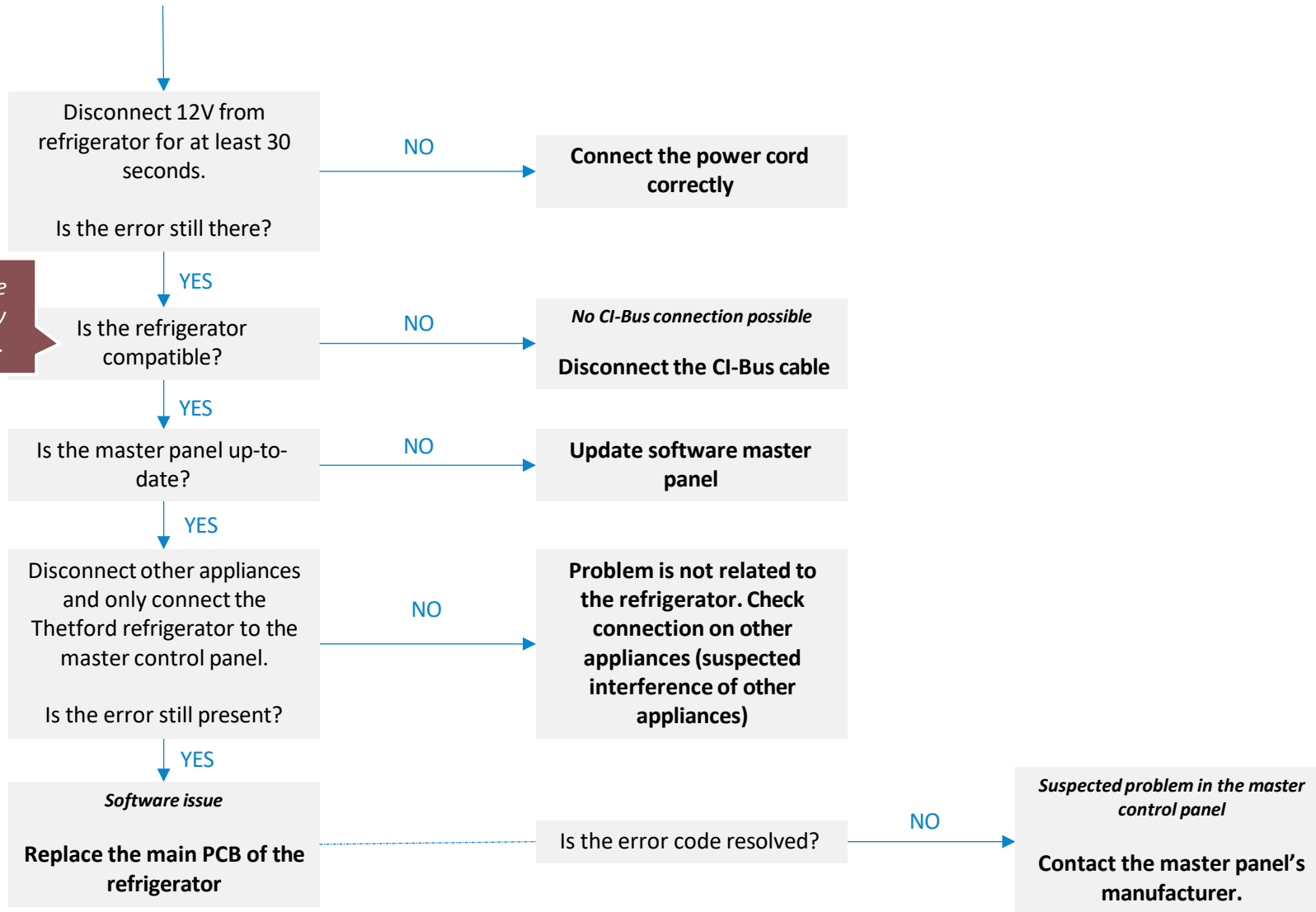

Error code 25: Voltage too low or too high

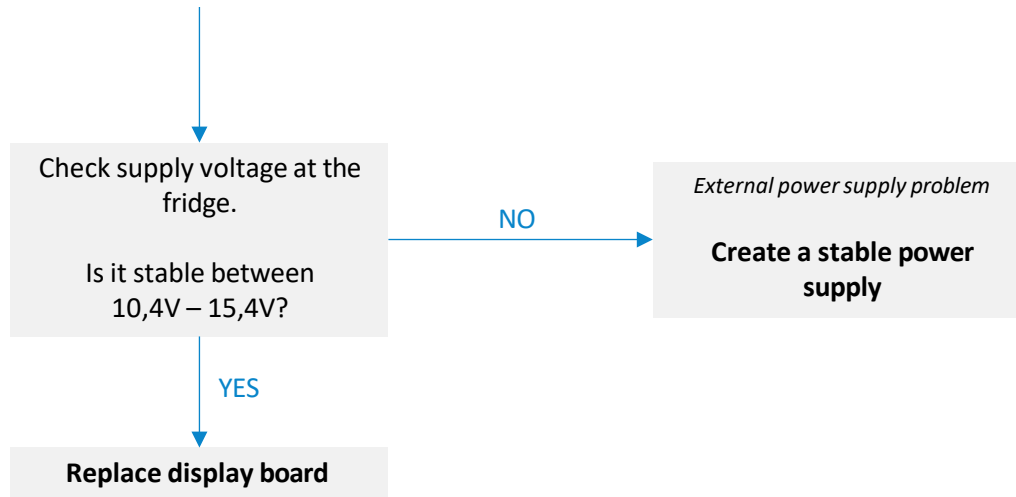

Note: the **display** also **functions** at voltages **below 10.4V** (from approx. 3.4 V). However, the compressor needs requires a minimum of 10.4 V is required. There is **no cooling** below 10.4 V.

No error code: 2-way valve defect

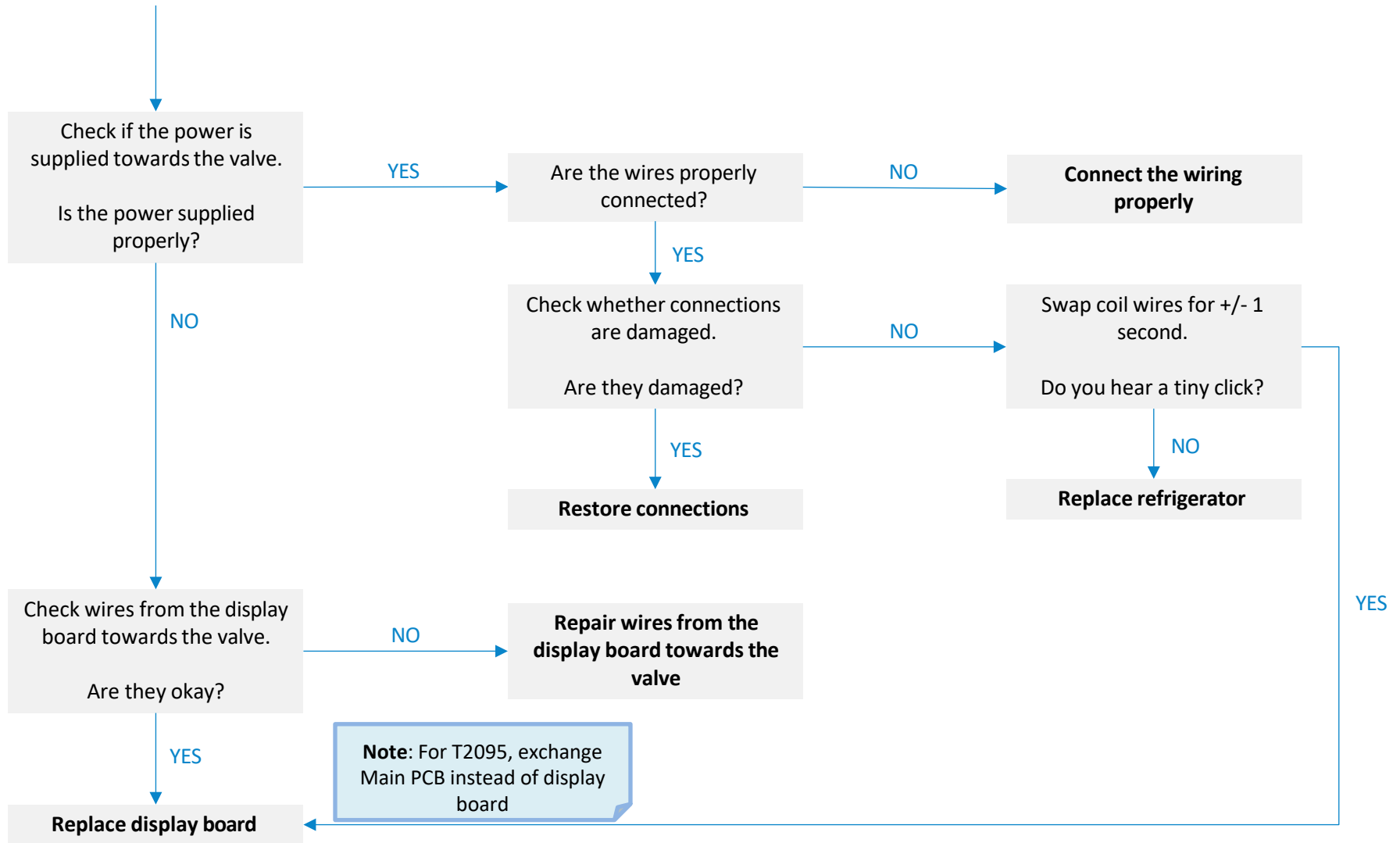

No error code: Thermal cut-out compressor

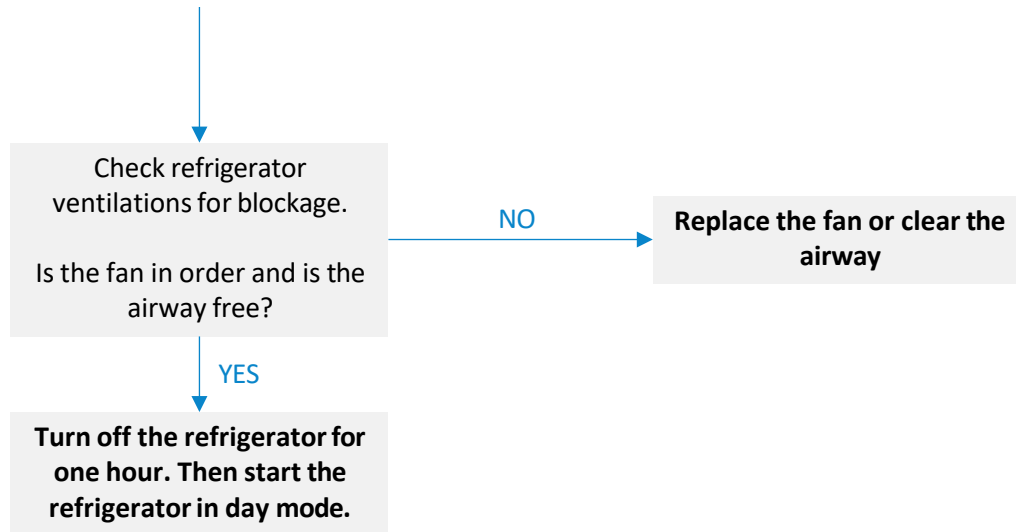

General problem solutions

Problem	Possible cause	Solution
Refrigerator is not cooling, compressor does not run at all	Battery voltage too low	Recharge battery
	Battery voltage too high	Check voltage battery, the inverter, solar panel (max 15.4V)
	Start delay of 1 minute (no issue)	Wait 1 minute
	Overheat due to high ambient	Turn off refrigerator for 1 hour, vent the vehicle, switch to day mode
	Vehicle fuse has blown	Check fuse rating, replace with described amp fuse rating
	Refrigerator fuse has blown	Check fuse rating, replace with described amp fuse rating
Frozen food compartment not freezing	Interior temperature in vehicle is lower than 16°C	Raise the temperature of the vehicle inside and/or select a higher cooling level to minimal level 4
Refrigerator is not cooling, compressor starts but switches off directly	Overheat due to high ambient temperature	Turn off refrigerator for 1 hour, vent the vehicle, switch to day mode
Refrigerator is overcooling	Temperature setting too high	Choose a lower temperature setting
Refrigerator is not cooling, compressor runs continuously	Go to a service centre	
Refrigerator cannot be switched on, display does not work (*see note)	Power supply not available	External power supply problem. Create stable power supply.
	Insufficient voltage at the control panel? (Voltage should be between 10.4V and 15.4V)*	
	Fuse is not working properly	
	Not all connectors are properly installed	
	Wiring is damaged	
	None of the above	Replace control panel

Note: the display also functions at voltages below 10.4V (from approx. 3.4 V). However, the compressor needs requires a minimum of 10.4 V is required. There is **no cooling** below 10.4 V.

General problem solutions

Problem	Possible cause	Solution
Refrigerator has insufficient cooling	Overheat due to high ambient temperature	Turn off fridge for 1 hour, vent the vehicle, switch to day mode
	Ventilation openings, complete or partially blocked	Clean or remove blockage
	Door is not properly closed	Close door, make sure door seal in good order
	Too much ice on evaporator (more than 3mm)	Defrost evaporator, make sure door seal is in good order
	The fan does not start.	Replace fan
	The ambient temperature is not correct. The refrigerator requires a minimum ambient temperature (passenger compartment) of 10°C. The T2090C and T2090E requires a minimum of 16°C. The maximum is 32°C (night mode), 38°C (T1090) and 43°C (T1152).	Ensure the correct ambient temperature
	The thermistor is not working	Replace the thermistor
Refrigerator makes more noise in night mode	High ambient temperature (more than 30°C)	Wait until the refrigerator has reached the selected temperature setting
	Warm products have been placed inside the refrigerator	
	Refrigerator is turned on after it has been off for a long time	
Refrigerator does not cool	A low temperature setting is selected	First try to remove the refrigerator and operate it completely autonomously (with fully self-sufficient operation, the pure function of the refrigerator can be tested without influenced by the vehicle installation). Replace the refrigerator.
	Refrigerator makes a continuous, clearly audible bubbling noise. It can be assumed that the compressor is not sufficiently full.	
	Check that the compressor starts. If the compressor is faulty or blocked, cooling cannot be performed. The compressor can be checked by bridging the "C" and "T" connections on the control card of the compressor's control board.	

Wiring diagram T2090C

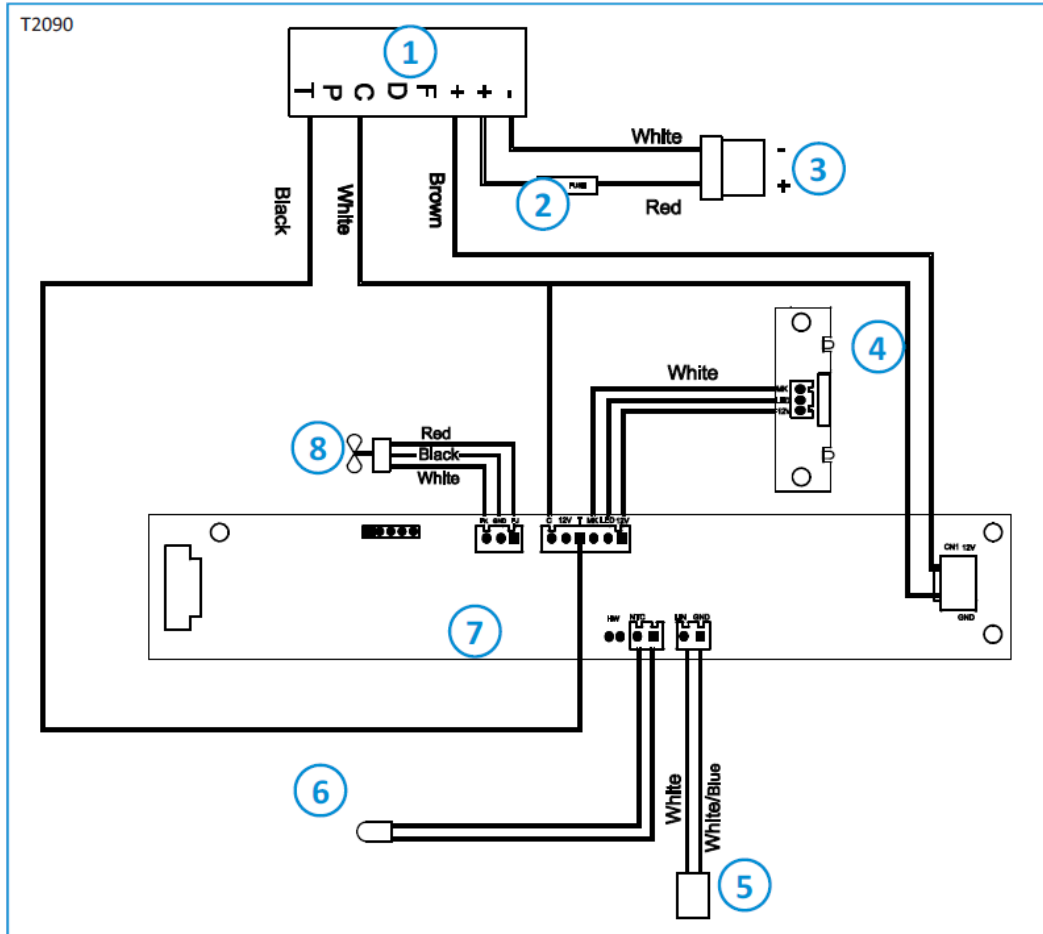

1. Main PCBA cooling unit
2. Fuse 15 A
3. Input power 12V DC
4. LED module
5. CI-BUS connection
6. Interior refrigerator thermistor
7. Display module
8. Fan cooling unit

Wiring diagram T2090E

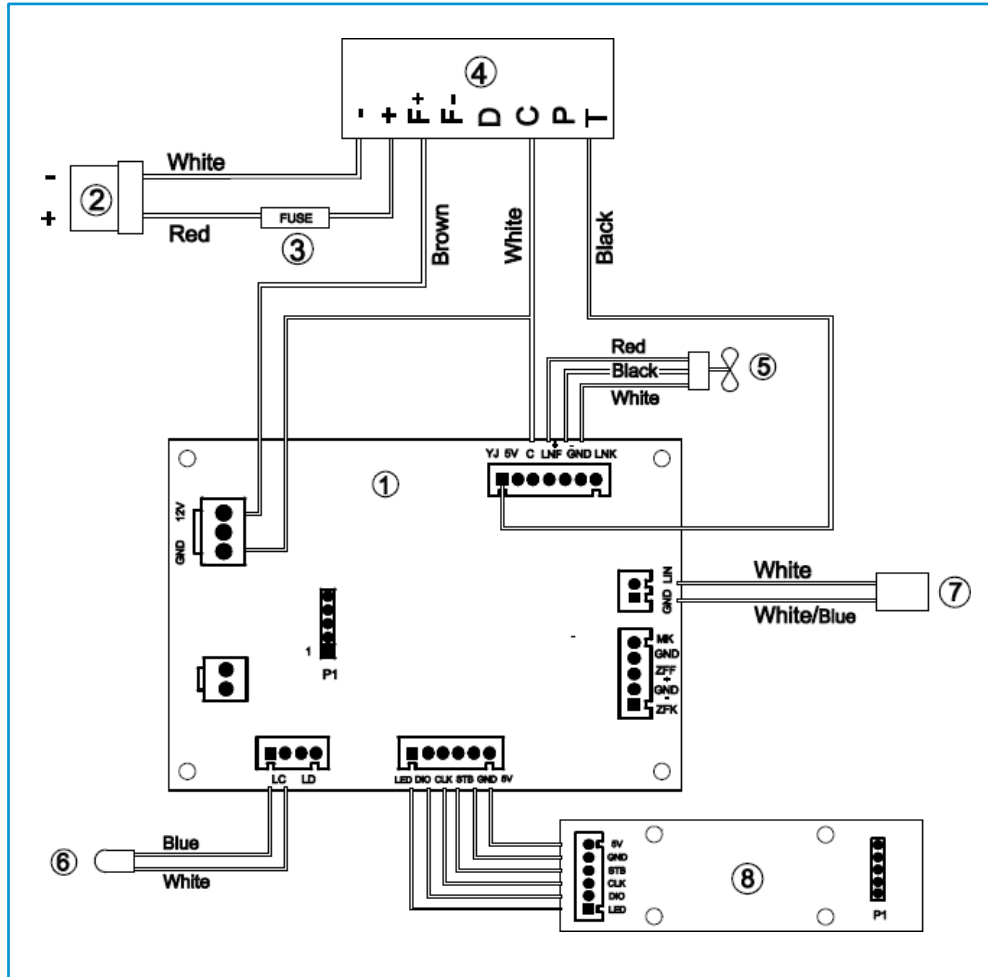

1. Main control panel
2. Input power 12VDC
3. Fuse 15 A
4. Main PCBA Cooling unit
5. Fan cooling unit
6. Interior refrigerator thermistor
7. CI-Bus connection
8. Display module

Wiring diagram T2095

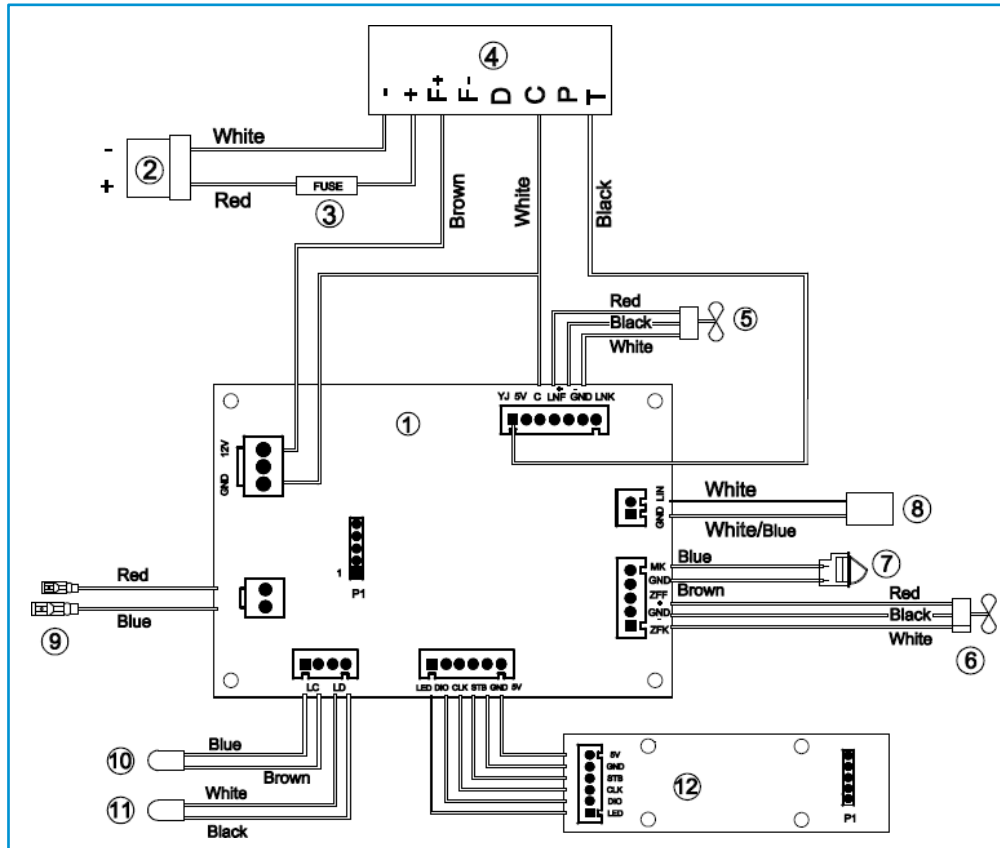

1. Main control panel
2. Input power 12VDC
3. Fuse 15 A
4. Main PCBA Cooling unit
5. Fan cooling unit
6. Interior fan
7. Interior light switch
8. CI-Bus connection
9. 2-way valve
10. Interior refrigerator thermistor
11. Interior freezer thermistor
12. Display module

Wiring diagram T2120 - T2152

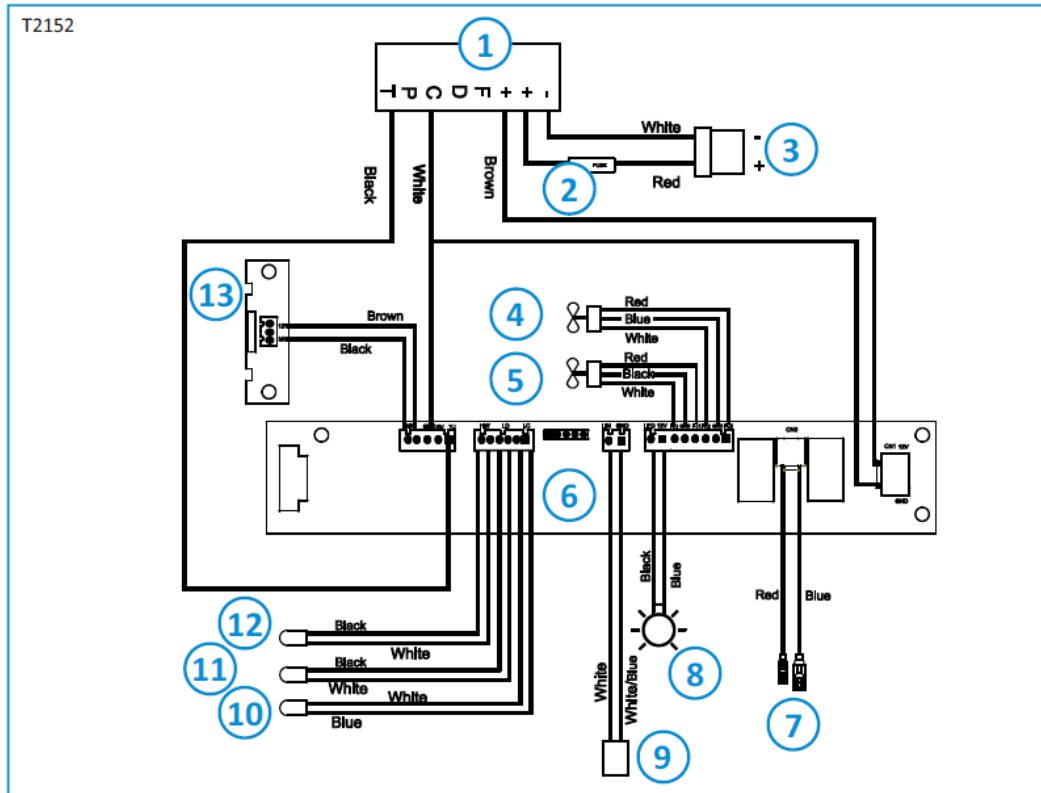

1. Main PCBA cooling unit
2. Fuse 15A
3. Input power 12V DC
4. Interior fan
5. Fan cooling unit
6. Display module
7. 2-way valve
8. Interior light
9. CI-BUS connection
10. Interior refrigerator thermistor
11. Interior freezer thermistor
12. Ambient temperatures thermistor
13. LED module

Wiring diagram T2138 - T2160 - T2175

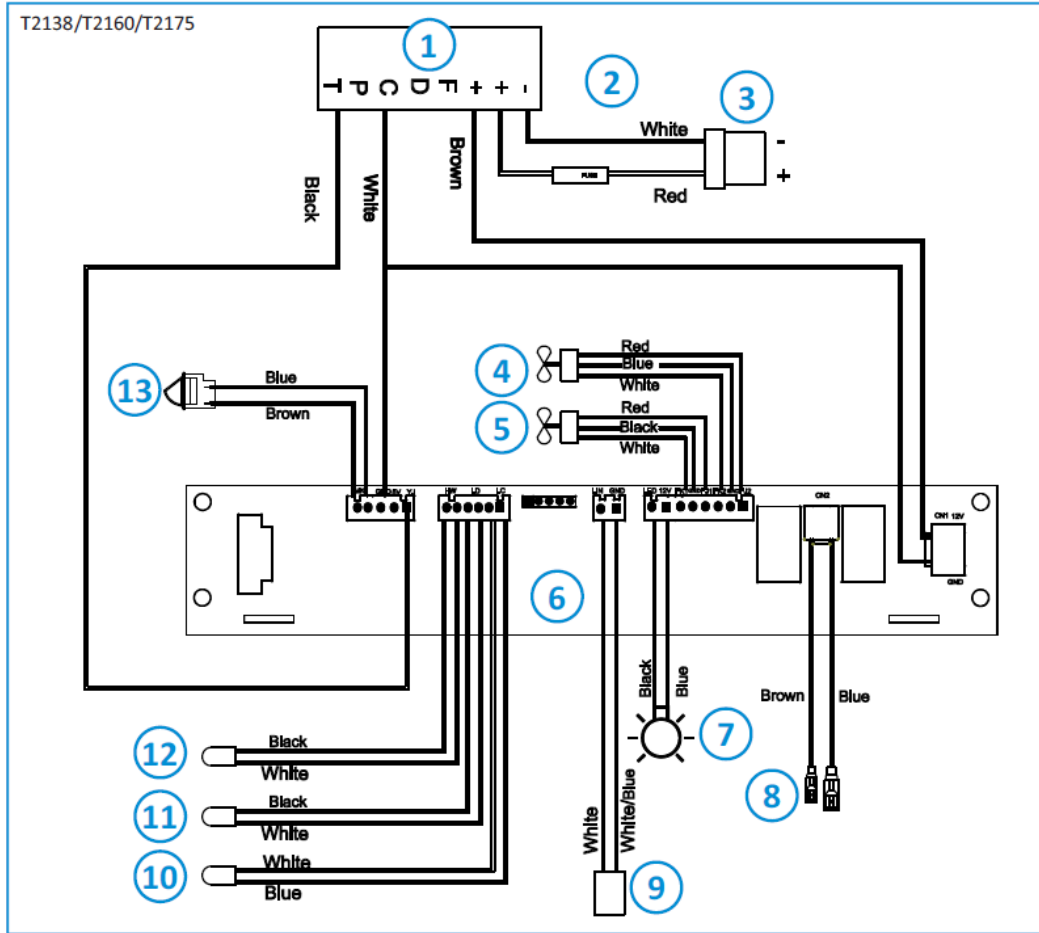

1. Main PCBA cooling unit
2. Fuse 15A
3. Input power 12V DC
4. Interior fan
5. Fan cooling unit
6. Display module
7. Interior light
8. 2-way valve
9. CI-BUS connection
10. Interior refrigerator thermistor
11. Interior freezer thermistor
12. Ambient temperatures thermistor
13. Interior light switch