

NORCOLD®



THE NEW AGE OF COLD

TEK II

REFRIGERATOR

MODELS

DC-351D

DC-340D-(F), (K)

DC-390D-(V)

OWNER'S GUIDE

SERVICE INFORMATION

IF SERVICE OR PARTS ARE REQUIRED, CONTACT THE NEAREST NORCOLD SERVICE CENTER. A NORCOLD SERVICE CENTER BOOKLET HAS BEEN INCLUDED WITH THE REFRIGERATOR INFORMATION PACKET

NORCOLD®

Printed in Japan
5/97
#5490 110 2030

Part No. 619752

This appliance has been designed for refrigerating purposes and is operable on a 12 Volt D.C. power supplies when installed as directed by this manual.

MODEL NO. _____ SERIAL NO. _____

The model and serial number may be located on the lower front trim rail or on the cabinet immediately adjacent to this trim rail.

Before installing your unit, record and retain the model and serial number for future reference and warranty purposes.

- DOOR OPENING, RIGHT & LEFT HAND, INTERCHANGEABLE
- CHANGEABLE DOOR PANEL

INSTALLATION

Your refrigerator should be located and secured on a solid surface with in the vehicle.

Before installing the cabinet into the opening, check to see if the D.C. supply be connected. In many cases, the D.C. supply can be connected from outside the vehicle by means of the baggage or access door.

Measure the opening to determine if you have the proper clearances for installation.

There is no need for allowing an area around the cabinet for additional insulation as the Norcold refrigerator is well insulated and requires no additional insulation.

Be sure your refrigerator is not in direct sunlight or near a gas stove, heater, or other heat-generating appliances.

Avoid installing your refrigerator close to warm lines, or warm air ducts. Your refrigerator has been thoroughly cleaned before shipment from the factory. It is advisable, however, to clean the interior once more before using.

Wipe the interior with a cloth moistened in warm water and wipe afterwards with a dry cloth.

□ VENTING

In order to assure efficient operation an adequate airflow over the rear mounted condenser of the refrigerator is required. Please refer to the illustration showing the various approved venting arrangements. Venting should be installed using any of the following combinations for truck use.

A-D, A-I, A-J, B-C, B-F, B-H, C-D, C-I, C-J, D-F, D-H, F-I, F-J, G-I, G-J, H-I, H-J,

Vent opening combinations should equal a minimum air flow of 50 square inches. These opening sizes are for minimum ventilation, however, we suggest providing as much ventilation as possible. The more air circulating over the condenser (located at rear) the more efficient the refrigerator will operate.

CAUTION

Failure to provide the necessary ventilation will result in shortened life expectancy of unit, poor refrigeration, continuous operation, accelerated battery discharge and void warranty.

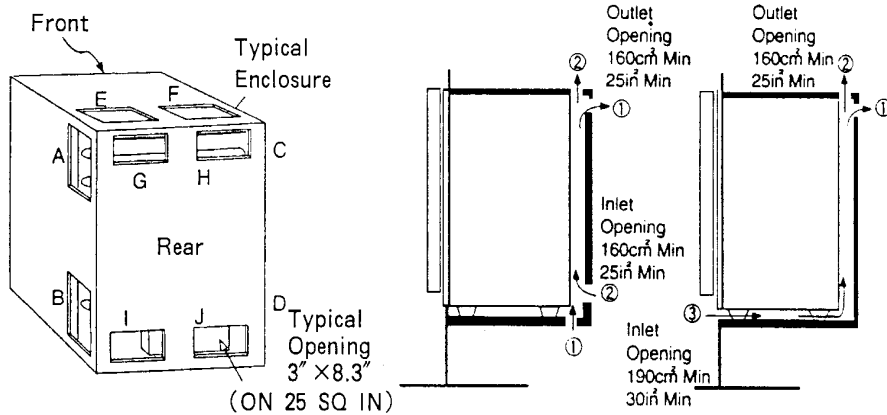

FOR TRUCK OR HEAVYDUTY USE IN MARINE & R/V. ON TEMPERATURE

In addition to suitable Vent opening, there must be cooling fan adding in order to get "Good cooling performance, Less current consumption, Higher ambient air temperature use such as 110° F "

Model	Vent hole size	C.F.M of Fan	Max. ambient air Temp. to use
DC-340D-(F)	min. 25 in ²	FAN INSTALLED	110° F
DC-351D	min. 25 in ²	25-28	110° F
DC-390D-(V)	min. 50 in ²	FAN INSTALLED	110° F

Cooling Fan position is recommended as follows,

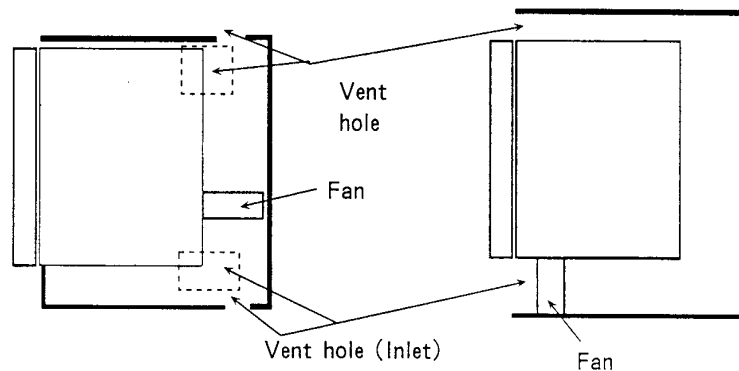

□ CONNECTING TO POWER SOURCE

Your refrigerator can be operated on D.C. (12 volt) from a battery.

CAUTION

The use of an Extension cord is not recommended.

12 VOLT D.C. OPERATION IN YOUR BOAT, TRAILER, CAMPER ETC.

The car battery voltage varies with the type of car you own. Most cars and boats use a 12 volt system. Your refrigerator needs a 12 volt battery.

If the battery voltage is too high (for example 24 volt), your refrigerator should not operate because of this refrigerator has a high voltage protector. On the other hand, its cooling power will decrease if the voltage is lower than 12 volt.

Set the temperature control dial to "OFF". Connect two (2) wires from the battery. REFERRING TO PULS/MINUS (+/-) INDICATIONS, D.C. lead wires located in the terminal box at the rear of the refrigerator.

CAUTIONS:1. CONNECT REFRIGERATOR DIRECT TO BATTERY

Any switches, lead wires or other electrical equipment should not be common with wiring between your refrigerator and battery, because this equipment often generates high voltage pulses and causes transistor defects in the inverter.

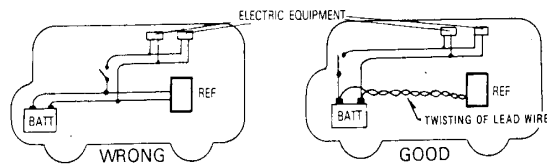

2. NEVER USE WIRING LESS THAN AWG #10 BETWEEN BATTERY AND REFRIGERATOR.

3. TWISTING OF LEAD WIRE IS RECOMMENDED.

To reduce the radio interference and induction of a high surge voltage from the outside, twisting of the lead wire is important.

Then, make a trial run of your refrigerator.

□ DIAL SETTING

Refrigerating temperature can be controlled by means of the thermostat dial, which also serves as the "ON-OFF" switch. Turn the dial clockwise from "OFF" and your refrigerator is switched "ON" just before the dial reaches the "1" position.

The interior temperature drops as the position is changed from "1" to "5", in this way, interior temperatures can be regulated freely.

To switch off your refrigerator, turn the dial counterclockwise to "OFF". The dial does not turn clockwise beyond "5". For efficient operation, regulate the temperature according to the types of foods stored.

CAUTION

- *Never store gasoline or other flammable vapors and liquids as these sometimes cause explosion.
- *Do not touch evaporator and metal parts of cabinet inside by wet hand. Sometimes, it may cause frostbite to your hand.
- *Do not remove or modify all the electrical live parts to avoid electric shock and trouble of your refrigerator.

MAINTENANCE OF YOUR BATTERY IS IMPORTANT

1. OVER COOLING DRAINS YOUR BATTERY.

In order to avoid an excessive drain of your battery, it is advisable to keep the temperature control dial setting at the #3 setting position when ambient temperatures are in the 70° to 90° F. When frozen food is stored in the freezing compartment, advisable the dial setting is the #5 setting at the same temperature conditions.

2. MAINTENANCE OF BATTERY IS IMPORTANT.

If the charge of your battery is not sufficient a decline in the cooling performance of your refrigerator can be expected.

3. NEVER EMPLOY A "QUICK CHARGER" TO YOUR BATTERY UNLESS THERMOSTAT HAS BEEN TURNED TO "OFF".

BATTERY CHARGER
OR AC/DC CONVERTER ETC.

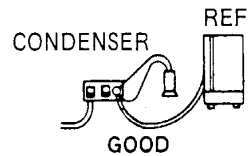
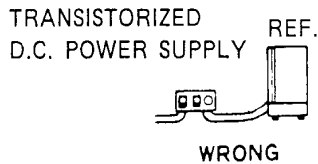
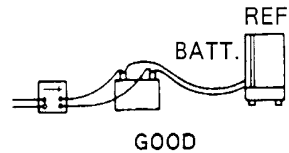
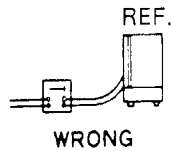

4. HOW TO CHECK THE BATTERY CHARGE LEVEL

Before placing the refrigerator into operation on the D.C. supply, it is important that the charge level of the battery be known. The following two methods are commonly used.

A) VOLTAGE CHECK

The voltage level of the battery will indicate to a certain degree the charge level of the battery. It is important, however, when using this method that a load be placed on the battery to assure a correct reading. Before applying the D.C. voltmeter to the battery terminals, it is recommended that a minimum of three interior vehicle lights or comparable load be turned on to eliminate the possibility of a false reading. A battery in a partially discharged state with no load applied will provide a 12 volt reading indicating full charge. The same battery with the load applied will read the true voltage level and indicate a recharge is required.

The voltage check system should only be used when the availability of a hydrometer is not present.

B) SPECIFIC GRAVITY CHECK

This method is by far the most accurate. The specific gravity reading when taken properly will indicate the true charge level of the battery.

A full charged battery will have a specific gravity reading of 1,260 to 1,280. When taking the readings in this manner, it is advisable to check all the cells. (3 for the six volt battery and 6 for the 12 volt)

If the battery is in good condition, all the cell readings will be approximately the same. If you find that one cell has a lower reading than any of the others, it is an indication that the battery is defective and should be replaced.

Battery recharge is recommended any time the specific gravity reading is less than 1,200.

FOR YOUR REFERENCE.....

The Wiring Diagram shown below is recommended for dual battery hookup.

NOTE

TO PROTECT THE INVERTER OF THE REFRIGERATOR SHUT-OFF THERMOSTAT INSIDE OF CABINET WHEN BATTERIES ARE "QUICK-CHARGED"

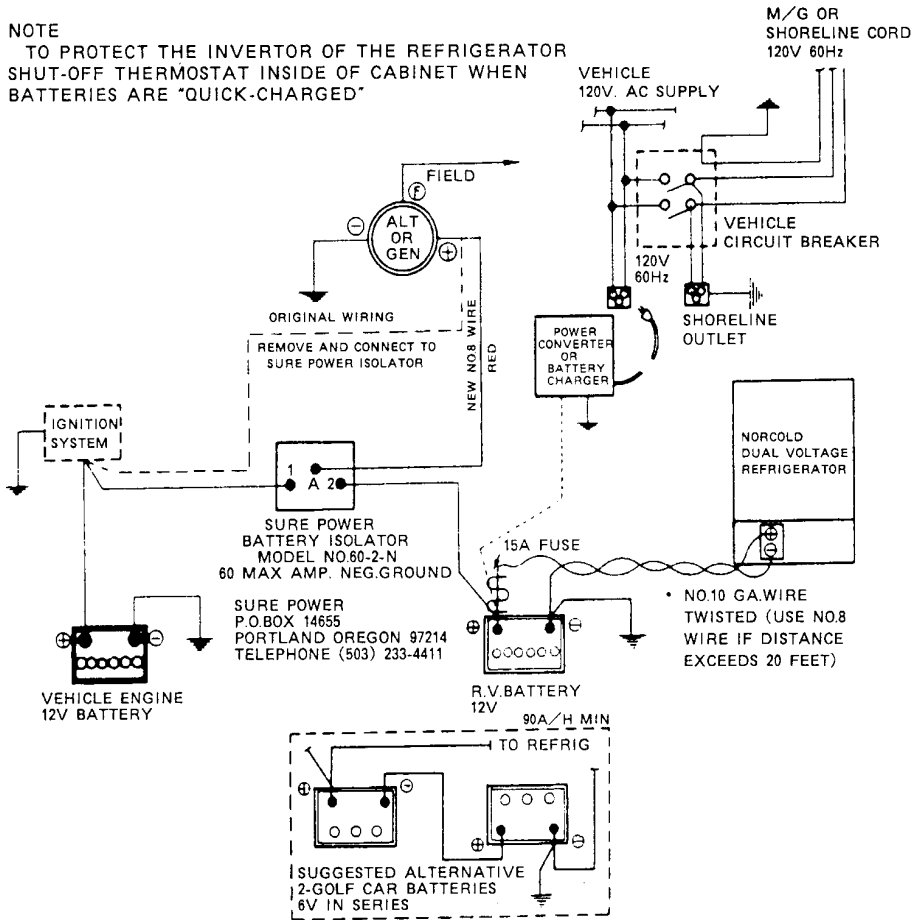

I. HOW TO REPLACE DOOR PANEL

1. Remove door from refrigerator
(Remove hinge pin by use of screw driver.)

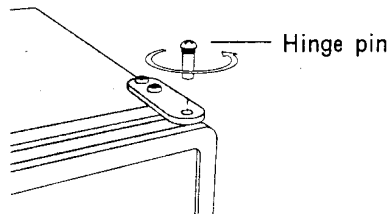

2. Remove lower panel frame.

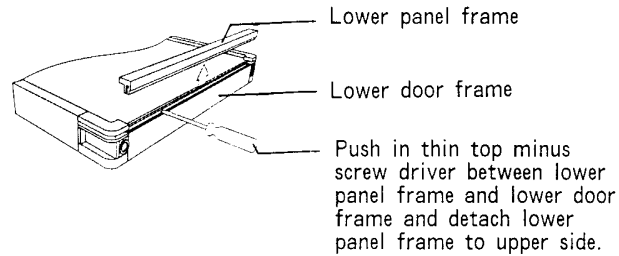

3. Pull out door panel gently.

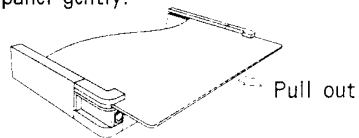

4. Insert a new door panel to the door slit.
Caution: Thickness of the door panel should be 4mm or under.
5. Fix the lower panel frame and replace the door following with the reverse order of disassembly.

II. HOW TO CHANGE DOOR OPENING DIRECTION FOR STOPPER PIN MODELS; DC-340D, DC-390D-V

1. Remove 2 hinge plates (both upper and lower side), door stopper plate and stopper pin by loosen of 6 screws.
2. Fix the hinge plates, the door stopper and the stopper pin as counter side of cabinet end.

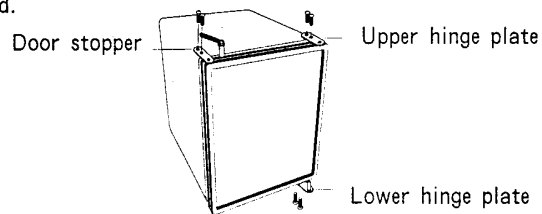

FOR STOPPER HOLDER MODELS; DC-351D

1. Remove 2 hinge plates (both upper and lower side) and door stopper by pulling out of 6 screws.
2. Fix the hinge plates at counter side of cabinet end.

3. Pullout screw of door stopper plate and remove door stopper holder.

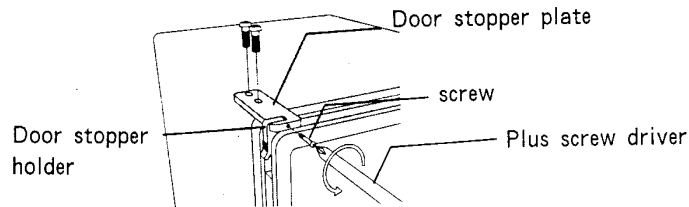

4. Turnover the door stopper plate and fix the door stopper holder so as to it can catch door at counter side of previous setting.

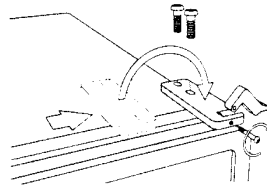

5. Fix the door stopper at counter side of cabinet end.

□ MAINTENANCE OF YOUR REFRIGERATOR

CLEANING BOX AND DOOR:

Wipe with a soft, dry cloth. To remove dirt, use a cloth moistened by a warm neutral detergent solution. Never use hot water. After cleaning, wipe with a dry cloth.

GASKET (door cushion):

Wipe away dirt with a soft cloth moistened by a neutral detergent. Do not soak the cloth excessively. If water gets inside, the insulating effect may become temporarily impaired.

ATTACHMENTS:

Wash all attachments in soapsuds. Rinse and wipe clean with a dry cloth.

CAUTION: Never use a brush, powder soap, cleanser, acid, benzene, gasoline, or thinner. These tend to leave scratches on the coating.

TO TURN OFF THE REFRIGERATOR:

Set the power switch to "OFF" and remove the plug from its socket.

When not in use the refrigerator should be emptied, cleaned and dried, and the door left ajar.

DEFROSTING

Set the temperature control dial to "OFF". When frost is melted, wipe the compartment plates with a soft, dry cloth.

LIMITED WARRANTY

NORCOLD®

600 Kuther Rd.,
P.O.Box 180
Sidney, Ohio 45365

This Limited Warranty is given by NORCOLD, Inc. ("Company") to the original consumer-purchaser of any new refrigerating equipment ("Equipment") supplied by the Company, excluding glassware and electric light bulbs, and will be effective for a period of one year from date of original purchase. The Company warrants, provided that the Equipment shall at all times have been in possession of and used by the original consumer-purchaser, that:

- A. The Company will provide free service and replacement of defective parts at no charge at all authorized Norcold Service Centers for a period of one year from the date of original purchase. This Limited Warranty covers labor costs incurred in removing and reinstalling the refrigerator only when necessary to replace a defective parts. The Company will pay inbound and outbound transportation costs of any defective part, for a 1 year period commencing with date of purchase. The original consumer-purchaser must pay all expenses incurred in making the equipment available at one of the Norcold Service Centers.
- B. The following procedure shall be followed by any original consumer-purchaser desiring to obtain performance under the terms of this Limited Warranty. The refrigerator must be brought to any of the Norcold Service Centers and the original consumer-purchaser must present evidence (1) to identify the original consumer-purchaser and (2) that the item claimed to be defective is still within the warranty coverage. If the original consumer-purchaser is unable to accomplish this task, written notice should be immediately directed to Norcold and advice will be promptly given concerning the manner in which warranty service may be obtained.
Inability to physically bring the refrigerator to a Norcold Service Center will not void the warranty, but any additional costs thereby incurred are solely for the account of the original consumer-purchaser.

C. The Company will not be liable under this Limited Warranty for any of the following.

- (1) Defects which arise by reason of transit damage, misuse, neglect or accident.
- (2) Manufacturing defects found at the time of purchase which are not communicated to the Company within 30 days.
- (3) Defects in glassware and electric light bulbs.
- (4) Defects arising from improper installation or adjustment of the Equipment.
- (5) The need for normal maintenance of this refrigerator, including the cleaning of the flue dilution assembly and orifice, and the adjustment of the gas pressure regulator in the case of EG models.
- (6) Defects arising from the improper use of parts or parts not manufactured or supplied by the Company in the course of repairs or replacements to the Equipment.

D. Employees and agents of the Company, and its authorized service representatives, have no authority to vary the terms of the Limited Warranty, which applies only to Equipment purchased and installed in the United States of America and the Dominion of Canada. The Company reserves the right to make any improvements or changes in parts or models without notice to any original consumer-purchaser.

E. The Company shall not be liable or in any way responsible for any loss or damage to person or property, or lost profits or other similar loss or damage that may result or be claimed to have resulted from a defect in any part of the Equipment covered by this Limited Warranty. Some states do not allow the exclusion or limitations of any incidental or consequential damages, so the above limitation or exclusion may not apply to you.

F. ANY IMPLIED WARRANTY OF MERCHANT ABILITY OR FITNESS FOR A PARTICULAR PURPOSE.

- (1) APPLICABLE TO A PART OR PARTS OF THE REFRIGERATOR IS LIMITED TO A PERIOD OF ONE YEAR FROM DATE OF PURCHASE.
- (2) SOME STATES DO NOT ALLOW LIMITATIONS ON HOW LONG AN IMPLIED WARRANTY LASTS. THE ABOVE LIMITATIONS MAY NOT APPLY TO YOU.

G. This Warranty gives you specific legal rights, and you may also have other rights which vary from state to state.